

Article number: 0101048
 Description: Retaining ring A 31 DIN 471
 Spring steel
 Note: Fitted with ZGA pilers

Measures

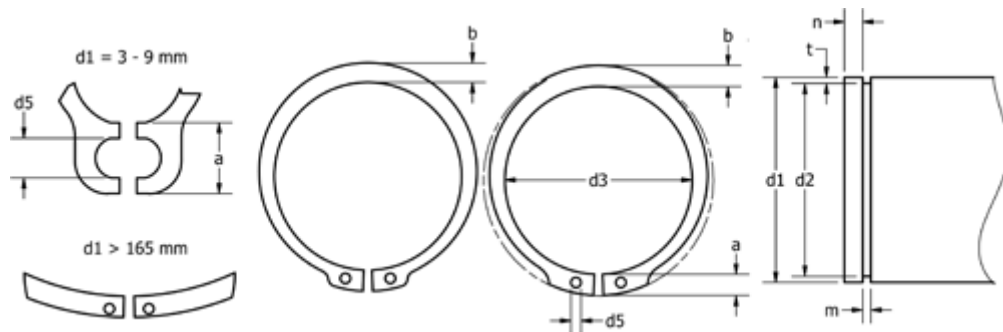

a max	= 5.1	FN kN	= 13.4	s	= 1.50
AN mm ²	= 81.0	FRg kN	= 5.60	t	= 0.85
b	= 3.5	FR kN	= 31.50	tol	= -0.21
d1	= 31	g	= 2.0	tol	= -0.06
d2	= 29.3	K kN-mm	= 62.80	tol	= +0,21-0,42
d3	= 28.6	m min	= 1.60	Tong	= ZGA-2
d5 min	= 2.5	n abl x 1000	= 18.0	Weight kg/1000	= 3.450
Description	= A31	Nominal drive	= 2.6		